

PHILIPS

EasyKey

Alpha

Push-pull
Smart Door Lock

User manual

Bluetooth Edition
Register products and get
support on the following sites
www.philips.com/support



Contents

1 Important information	02	5 How to use your EasyKey	15
Security		Unlock	
Caution		Unlock from outside	
Disposal of used		-With a PIN code	
Products and batteries		-With a fingerprint	
		-With a card	
2 Install your EasyKey	03	Unlock from inside	
Packaging list		-With handle	
Exploded views		-With Close button	
Pre-installation instructions		Lock	
Installation steps		-Auto/Manual modes	
		-Lock from outside	
3 Get to know your EasyKey	08	-Lock from inside	
Outside escutcheon		Inside Deadlock	
Inside escutcheon		Mechanical key opening	
4 How to set up your EasyKey	09	6 Other functions	18
-Modify Master PIN code		Safe handle function	
-User settings		Restore to factory settings	
-Delete a user		One-button mute function	
-System settings		Outside forced lock function	
-Extended functions			
-System query		7 Meanings & Use of the indicators	20
-Local Query		Door status indicator	
-Bluetooth settings		Low battery indicator	
		Outside forced lock indicator	
		Mute mode indicator	
		Inside deadlock indicator	
		System lock indicator	
		[CLOSE] button indicator	
		8 Troubleshooting	22
		Alarm types and alarm modes	
		How to apply an emergency power	
		How to replace batteries	

1 Important information

Security

◆Before using Philips EasyKey, please read and understand all instructions. Damage caused by non-compliance with the instructions will not be covered by warranty.

◆Use only the manufacturer-specified accessories/components.

◆Use only the alkaline batteries the product is equipped with, or use the same specification type of alkaline batteries.

◆Do not forcibly disassemble this product to avoid triggering an alarm or damaging the product.

◆Do not scrape the fingerprint sensor with sharp objects, otherwise it may cause permanent damage.

◆Do not expose products to environments where there is water leakage or splashing.

◆Do not expose the product to corrosive substances to prevent damaging the protective cover.

◆Do not hang objects on the handle, in case it might affect the normal use of the lock.

◆Please clean the product with a soft cloth.

◆Do not remove the battery during setting up and operating.

◆Please let a professional technician to install the door lock and follow the installation guidelines provided. Do not disassemble the lock by yourself. Keep the relevant sealed stickers properly. Do not easily disclose the password information.

◆Please modify the default master PIN code immediately after finishing installing and debugging, and keep the mechanical key properly.

◆Please replace all the batteries immediately if there is a low battery alarm. Please make sure to correctly match the poles (+/-) when installing the batteries.

Caution

◆Do not place the battery near fire sources to avoid explosion.

◆Do not use any emergency power supply that does not meet the safety requirements to power up the product.

◆Do not connect the 2 poles of the batteries with metals to avoid short circuit which may lead to an explosion.

◆Please make sure any component replacement is executed by Philips, Philips authorized service center or professional technicians.

◆Do not use accessories or parts that have been produced by other manufacturers or have not been specifically recommended by Philips. The use of such accessories and parts may void your warranty.

Disposal of used products and batteries

◆You can have your locks reclaimed at Philips authorized service centers. You will receive corresponding compensation if your products meet our conditions.

◆Please familiarize yourself with the local electronic product collection system.

◆Please follow local regulations and do not discard used products into ordinary household waste.

◆Proper disposal of used products can help to avoid potential negative impacts on the environment and human health.

◆Batteries must not be disposed of with ordinary household waste.

◆Please familiarize yourself with the local regulations on batteries classification recycling. Disposing of batteries properly can help avoid a negative impact on the environment and human health.

2 Install your EasyKey

Packaging list

This packaging list is for reference only. Please refer to the actual packaging contents.

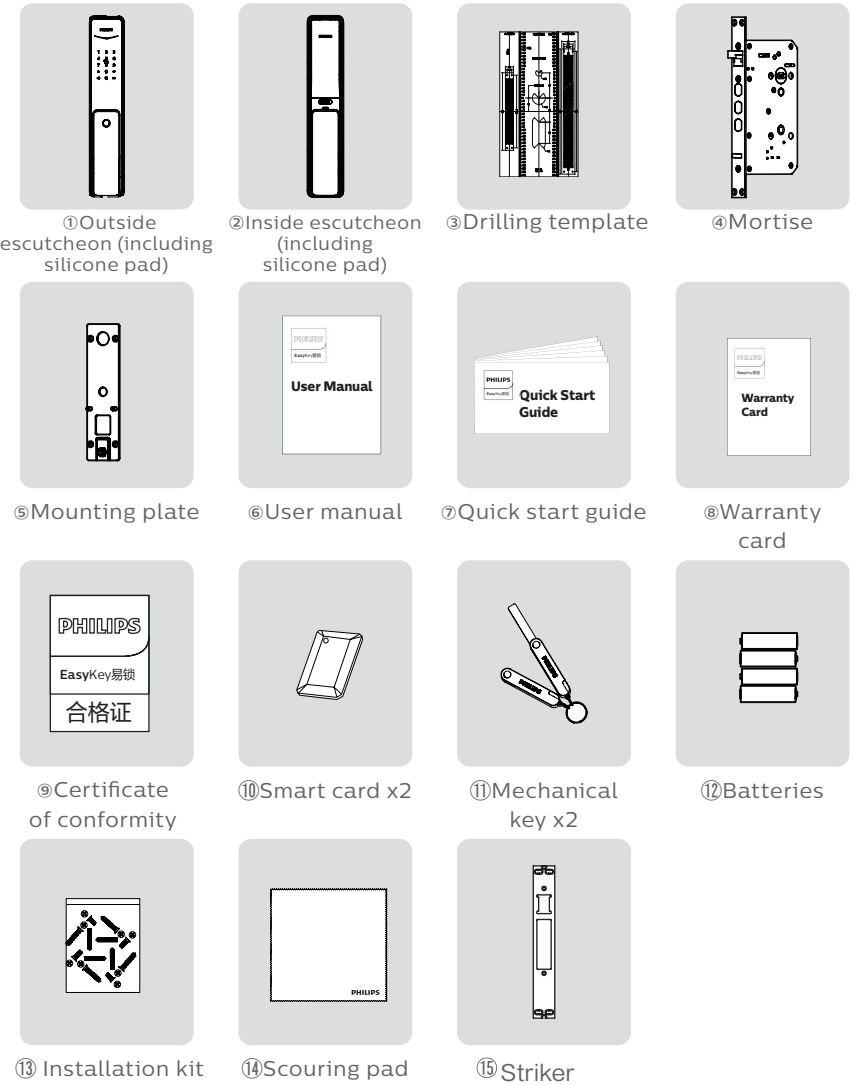

Exploded Views

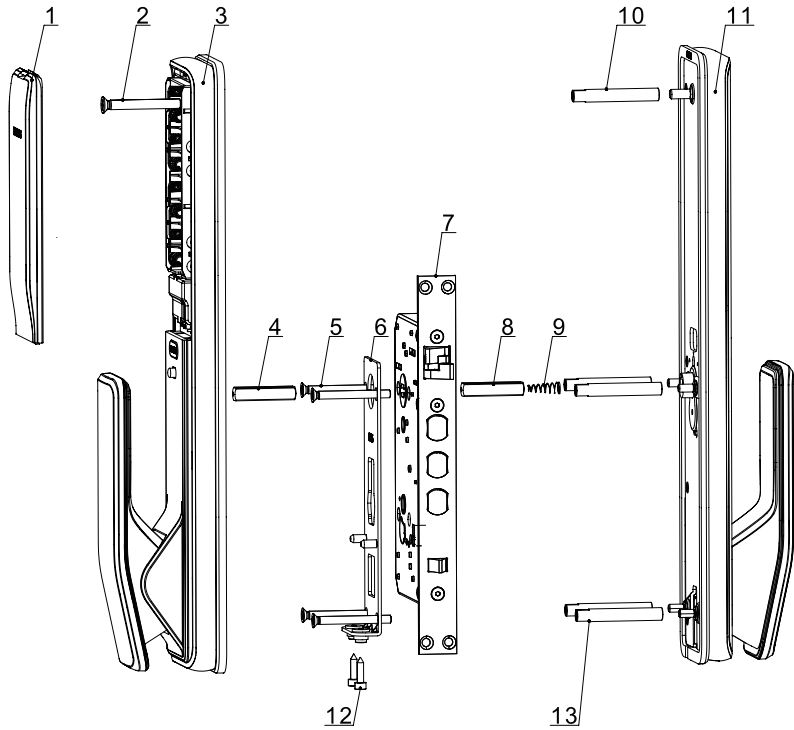

1. Battery cover (x1)

2. M6 chamfer head screw (x1)

3. Inside escutcheon component (x1)

4. Square shaft (x2)

5. M5 chamfer head screw (x4)

6. Mounting plate (x1)

7. Mortise (x1)

8. 35mm square shaft (x1)

9. Compressed Spring (x1)

10. M6 screw tube (x1)

11. Outer escutcheon component (x1)

12. M4 hexagon screw (x2)

13. M5 screw tube (x4)

Pre-installation instructions

Step 1 | Check the door opening direction

This product can be installed on doors of 4 types of opening directions: left-out pull, right-in push, right-out pull and left-in push.

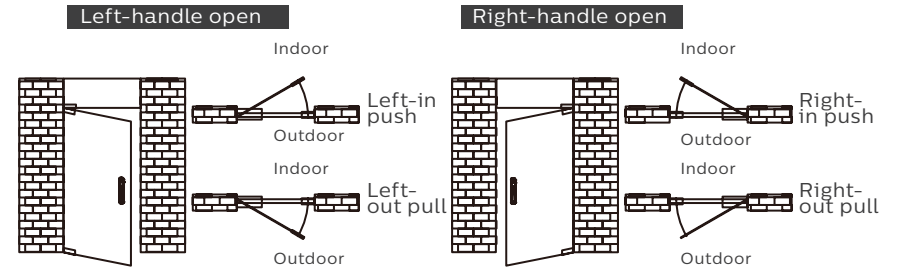

Step 2 | How to switch between push and pull

Please fix the screws in proper locations according to the door opening direction.

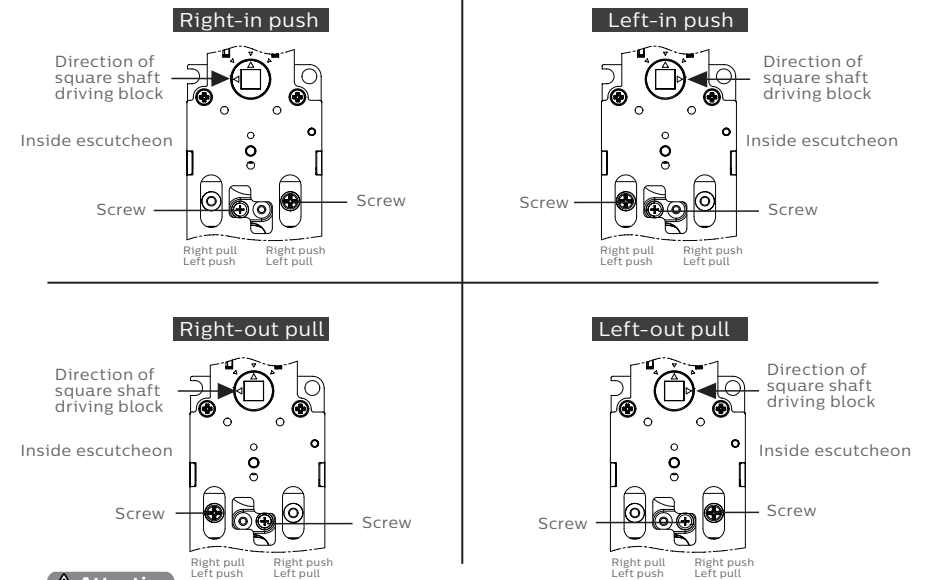

⚠ Attention

1. Use proper installation kit according to the door thickness.

2. The default installation kit is applicable to doors of 38-60 mm thickness. If the thickness of your door is not within this range, please contact us.

Installation steps

The following installation steps apply to left-open doors. For right-open doors, please read the chapter [Pre-installation instructions] carefully and make needed adjustments.

- 1 Use the drilling template to drill the needed holes on the door and mount the mortise into the door.
- 2 Tighten the 4 anchor screws on the mortise.

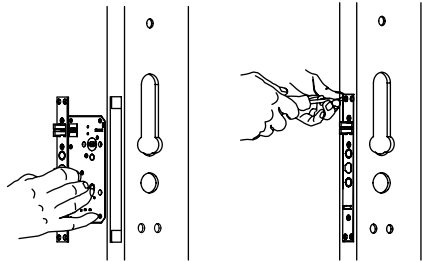

Attention
Please make sure the main dead bolt is retracted during installation.

- 3 Install the connecting screw tubes on the outside escutcheon. Place the square shaft and compressed spring into the hole of the handle.

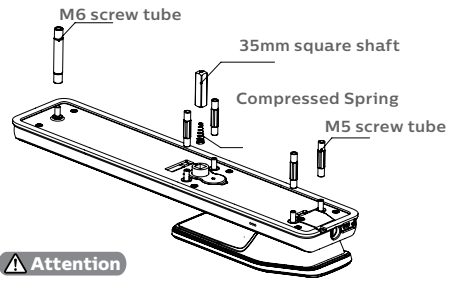

Attention
Select a square shaft and connecting screw tube with appropriate length.

- 4 Pass the cable through the hole on the door. The square shaft needs to be inserted into the rotary hole on the mortise, so that the outer escutcheon stays close to the outside door.
- 5 Tighten the mounting plate with the 4 M5 chamfer head screws against the inside of the door.

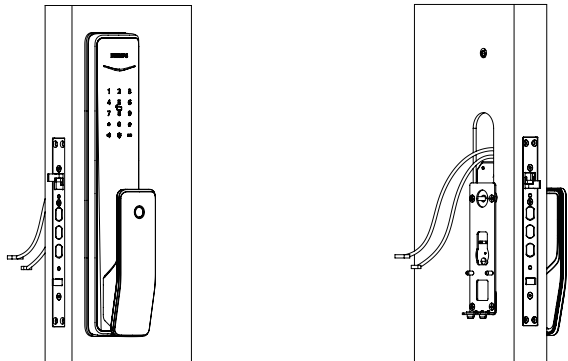

- 6 Install the compressed spring and square shaft into the inside escutcheon accordingly.

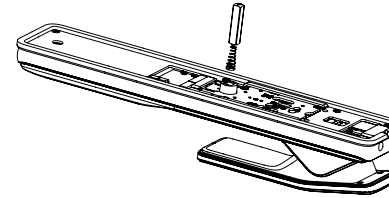

- 7 Insert the connection wire of the outside escutcheon and the motor wire into the corresponding holes on

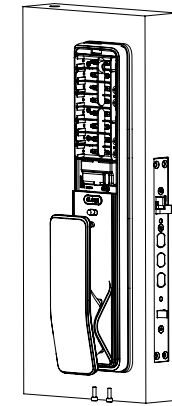

the inside escutcheon, then align the square shaft on the inside escutcheon with the rotary hole on the mortise and insert it to make sure the inside escutcheon is kept close to the inside of the door.

Attention
Please hide the extra connecting wires into the hole of the door.

- 8 Tighten the M6 chamfer head screws and the 2 M4 hexagon screws.
- 9 Put in the batteries and close the battery cover. Then fix the striker to finish the installation.

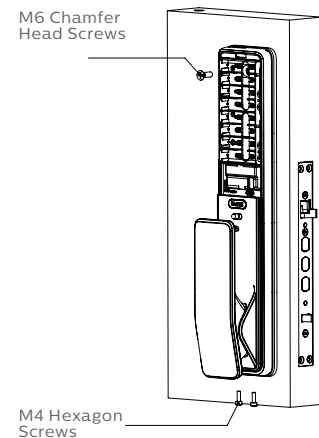

- 10 Please check if all components are connected properly, such as the push-pull handle, the safe handle switch and the mechanical key.

Attention
After fixing the striker, please test if the door can be opened and closed smoothly.

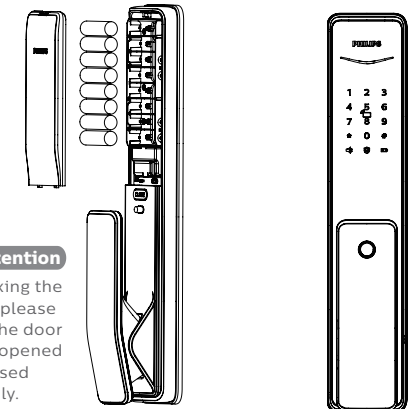

3 Get to know your EasyKey

Outside escutcheon

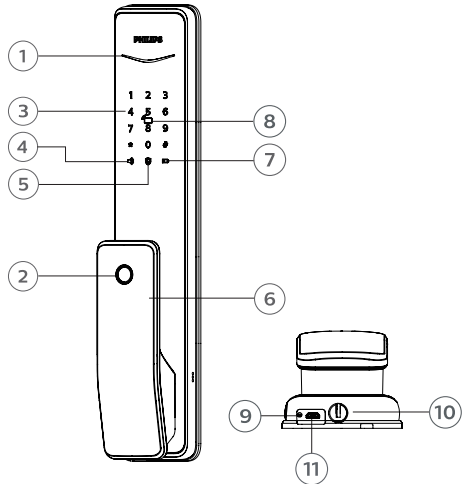

1	Door status indicator
2	Fingerprint sensor
3	Keypad
4	Mute button
5	Outside forced lock button
6	Push-pull handle
7	Low battery indicator
8	Card reader
9	Reset button
10	Mechanical key hole
11	Emergency power interface

Inside escutcheon

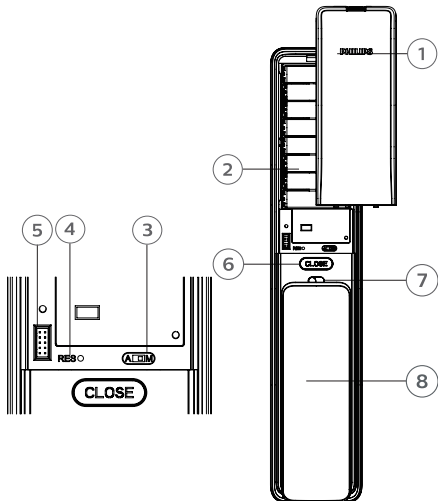

1	Battery cover
2	Battery cabinet
3	Auto/Manual mode switch
4	Reset button
5	Extended module interface
6	Close button
7	Safe handle switch
8	Push-pull handle

4. How to set up your EasyKey

Pre-setup Instructions:

◆ There are 2 operating modes in the EasyKey:
General mode and dual verification mode.

General mode	Dual verification mode
--------------	------------------------

Unlock with any registered identity information	Unlock with any two of PIN code, card and fingerprint
---	---

◆ User Number
You can delete a single user information by its user number without having to delete everything.

◆ You can record the user information in the following table for future query.

Number	Name	Fingerprint	PIN Code	Card
00				
01				
02				
03				
04				
05				
06				
07				
08				
09				

◆ Icon annotation

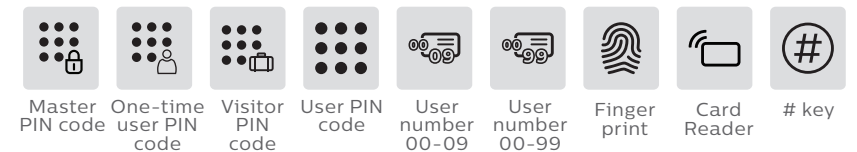

⚠ Attention

1. Press [*] key to return to the previous menu.
2. The default master PIN code is 12345678.

◆ How to enter master mode:

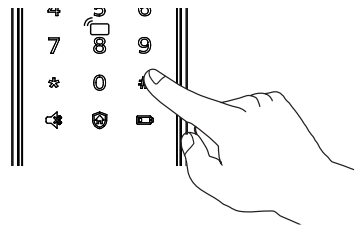

② Press [#] before inputting any other numbers. Enter your master PIN code and confirm with [#]. Then you are in master mode.

Modify master PIN code



Press [#], enter master PIN code and confirm with [#].



Press [1] to modify master PIN code.



Enter the new master PIN code and confirm with [#]. Re-enter the new master PIN code and confirm with [#]. After hearing a voice prompt of "Succeeded", press [*] several times until you exit master mode.

User settings

Register a user PIN code



Press [#], enter master PIN code and confirm with [#].



Press [2] to enter user registration, then press [1] to register a new user PIN code, which will be automatically numbered and broadcasted by the system.



Enter a user PIN code of 6 to 12 digits and confirm with [#]. Then re-enter it and confirm with [#]. After hearing a voice prompt of "Succeeded", press [*] several times until you exit master mode.

Register a one-time user PIN code



Press [#], enter master PIN code and confirm with [#].



Press [2] to enter user settings, then press [2] again to enter one-time PIN code registration.



Enter a one-time user PIN code of 6 to 12 digits and confirm with [#]. Re-enter and press [#] to confirm. After hearing a voice prompt of "Succeeded", press [*] several times until you exit master mode.

Register a fingerprint



Press [#], enter master PIN code and confirm with [#].



Press [2] to enter user settings, then press [3] to enter fingerprint registration. The system will automatically number the fingerprint and broadcast the number.



Place your finger against the sensor. After hearing a voice prompt of "Take away your finger and enroll again", please take away your finger and re-place it against the sensor. After hearing a voice prompt of "Succeeded", press [*] several times until you exit master mode.

Register a card



Press [#], enter master PIN code and confirm with [#].



Press [2] to enter user adding, then press [4] to enter card registration. The system will automatically number the card and broadcast the number.



Hold the card close to the card reader until you hear a beep. After hearing a voice prompt of "Succeeded", press [*] several times until you exit master mode.

User Information Deletion

Delete a user PIN code



Press [#], enter master PIN code and confirm with [#].



Press [3] to enter user deletion, then press [1] to enter user PIN code deletion. Press [1] again to delete a single user PIN code.



Enter the 2-digit [user number] (00-09) of the user PIN code that is to be deleted and press [#] to confirm. After hearing a voice prompt of "Succeeded", press [*] several times until you exit master mode.

Delete all user PIN codes



Press [#], enter master PIN code and confirm with [#].



Press [3] to enter user deletion, then press [1] to enter user PIN code deletion. Press [2] to delete all user PIN codes. After hearing a voice prompt of "Succeeded", press [*] several times until you exit master mode.

Delete a one-time user PIN code



Press [#], enter master PIN code and confirm with [#].



Press [3] to enter user deletion, then press [2] to enter one-time user PIN code deletion.



After hearing a voice prompt of "Succeeded", press [*] several times until you exit master mode.

Delete a fingerprint



Press [#], enter master PIN code and confirm with [#].



Press [3] to enter user deletion, then press [3] again to enter fingerprint deletion. Press [1] to enter single fingerprint deletion.



Enter the 2-digit [user number] (00-99) of the fingerprint that is to be deleted and confirm with [#]. After hearing a voice prompt of "Succeeded", press [*] several times until you exit master mode.

Delete all fingerprints



Press [#], enter master PIN code and confirm with [#].



Press [3] to enter user deletion, then press [3] again to enter fingerprint deletion. Press [2] to delete all fingerprints. After hearing a voice prompt of "Succeeded", press [*] several times until you exit master mode.

Delete a card



Press [#], enter master PIN code and confirm with [#].



Press [3] to enter user deletion, then press [4] to enter card deletion. Press [1] to delete a single card and then press [*] several times until you exit master mode.

Delete all cards



Press [#], enter master PIN code and confirm with [#].



Press [3] to enter user deletion, then press [4] to enter card deletion. Press [2] to delete all cards. After hearing a voice prompt of "Succeeded", press [*] several times until you exit master mode.

System date initialization

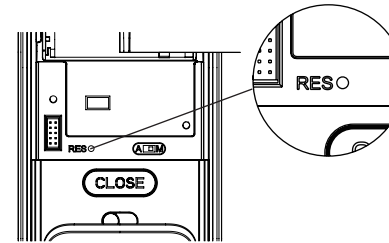

Remove the battery cover and double press the [RES] button with a sharp object, until you hear a voice prompt of "Restored to factory settings". All user information will be emptied.

System Settings

Language Settings



Press [#], enter master PIN code and confirm with [#].



Press [4] to enter system settings, then press [1] to enter language settings.



Adjust the language as needed: For Chinese, press [1]; for English, press [2]. After hearing a voice prompt of "Succeeded", press [*] several times until you exit master mode.

⚠ Attention

The default language is English.

Volume settings



Press [#], enter master PIN code and confirm with [#].



Press [4] to enter system settings, then press [2] to enter volume settings.



Adjust the volume as needed: For higher volume, press [1]; for lower volume, press [2]; for mute mode, press [3]. After hearing a voice prompt of "Succeeded", press [*] several times until you exit master mode.

⚠ Attention

The default volume is "higher volume".

Switch to dual verification mode



Press [#], enter master PIN code and confirm with [#].



Press [4] to enter system settings, then press [3] to choose verification method.



For single verification, press [1]; for dual verification, press [2]. After hearing a voice prompt of "Succeeded", press [*] several times until you exit master mode.

Extended Functions



Press [#], enter master PIN code and confirm with [#].

5

Press [5] to enter extended functions.

1 or 2

To join a network, press [1]. To exit a network, press [2]. Before setting up the extended functions, please download and open the Philips EasyKey APP via your mobile phone.

⚠ Attention

The extended functions are optional.

System Query

Security code query



Press [#], enter master PIN code and confirm with [#].

6 1

Press [6] to enter system query, then press [1] to get the serial number (security code) automatically broadcasted.

⚠ Attention

Directly enter 400# to start system query.

Local Query



Press [#], enter master PIN code and confirm with [#].

6 2

Press [6] to enter system query, then press [2] to get the software version automatically broadcasted.

⚠ Attention

Directly enter 114# to start local query.

Bluetooth Settings



Press [#] and input master pin code, then press [#] to confirm.

7

Press [7] to enter Bluetooth settings.

3 *

To disable Bluetooth, press [3]. After hearing a voice prompt of "Settings succeeded", press [*] back to previous menu until you exit master mode.

⚠ Attention

1. Bluetooth switch shortcut, directly input 403# to open the Bluetooth module, input 404# to turn off the Bluetooth module.
2. When the Bluetooth is off, please press [1] to enable Bluetooth.

5. How to use your EasyKey

Unlock | Opening from outside

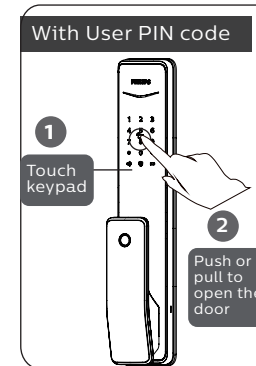

- ① Touch the keypad and light up the buttons. Enter the registered user PIN code and press [#] to confirm.
- ② After hearing a voice prompt of "Door opened", push or pull the handle to open the door.

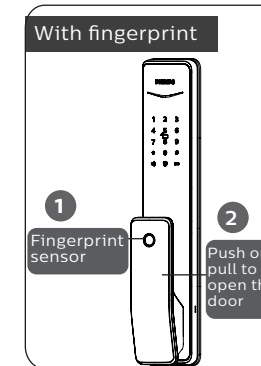

- ① Place your registered finger properly on the sensor.
- ② After hearing a voice prompt of "Door opened", push or pull the handle to open the door.

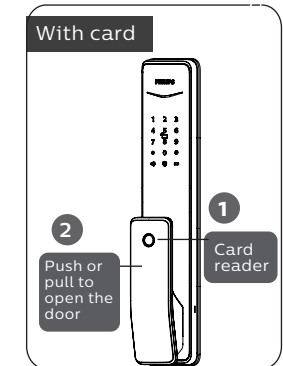

- ① Place your registered card on the card reader.
- ② After hearing a voice prompt of "Door opened", push or pull the handle to open the door.

Unlock | Opening from inside

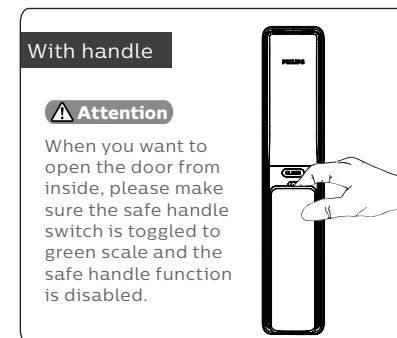

Philips EasyKey employs indoor fast opening motise allowing you to directly push or pull the handle to unlock.

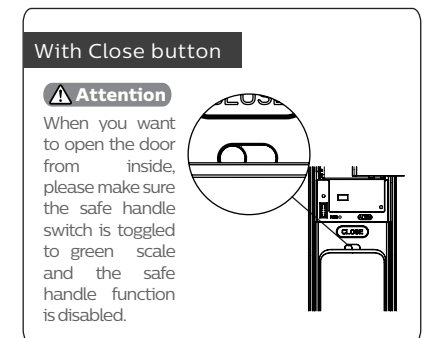

Only after you double press the [CLOSE] button within one second can the deadbolt pop up and lock the door. Then pull/push the handle to unlock the door.

Lock | Auto/Manual modes

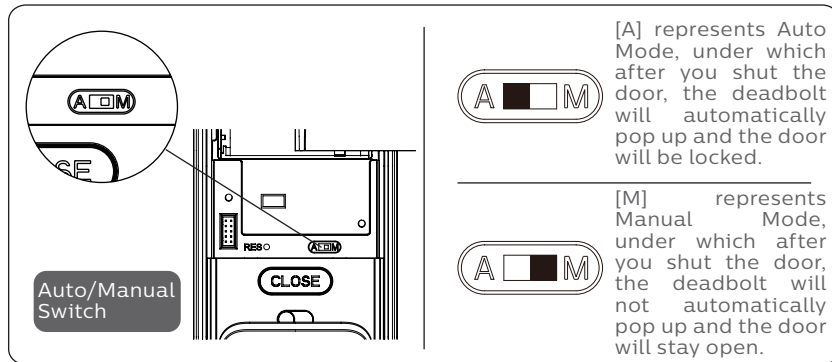

Lock from outside the door



When the lock is adjusted to Auto Mode, shutting the door will make the deadbolt automatically pop up and there will be a voice prompt of “Door closed”.



When the lock is adjusted to Manual Mode, the deadbolt won't pop up automatically after shutting the door. Only fingerprint, card or PIN code verification can make it automatically pop up. After the door is locked, you will hear a voice prompt of “Door closed”. Under Manual mode, after closing the door, you can wake up the outside escutcheon,

Lock from inside the door



When the lock is adjusted to Auto Mode, shutting the door will make the deadbolt automatically pop up and there will be a voice prompt of “Door closed”.



When the lock is adjusted to Manual Mode, the deadbolt won't pop up automatically after shutting the door. Only after you double press the [CLOSE] button within one second can the deadbolt pop up and lock the door. After the door is locked, you will hear a voice prompt of “Door closed”.

Deadlock from inside

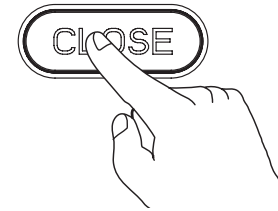

After the door is locked, long press the [CLOSE] button. The button will flash once in red and there will be a voice prompt of “Inside deadlock enabled”.

⚠ Attention

Under inside deadlock mode, all functions of the outside escutcheon will be locked. If you try to wake up the system manually, the keypad area will display the combination of “15937(X)” and there will be a voice prompt of “Inside deadlock enabled” reminding you that the door has been dead locked from inside. Under deadlock mode, all operations of the outside escutcheon are disabled. Only Master PIN code verification or mechanical key opening is required to release the door from deadlock mode.

Mechanical key opening

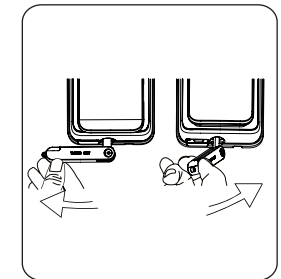
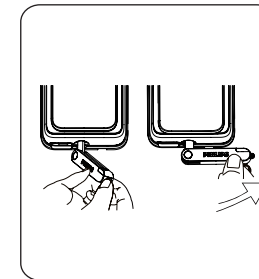
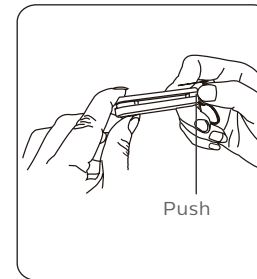

- ① Cut the mechanical key box and take out the key shell. Push the cover aside and reveal the key itself.
- ② Insert the key into the key hole and keep the key and key shell vertical to each other. Rotate the key shell towards the handle for 90° until it becomes close to the door surface.
- ③ Rotate the key shell downwards for 180° to make the key shell parallel to the ground. Then rotate the key shell horizontally towards the handle to unlock the door.

⚠ Attention

We suggest that you do not use the mechanical key for daily unlocking. Use the key only for emergencies, for example when the battery is dead, when the PIN code is forgotten, or when the system fails to work properly.

6 Other functions

Safe handle function: Lock the handle from inside

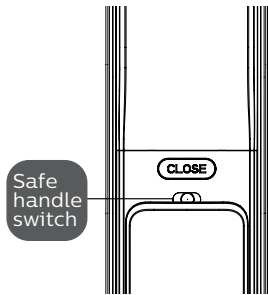

Function:
Lock the handle from inside and prevent unlocking from inside.

- How to use:**
1. Enable safe handle function: Toggle the switch to red scale.
 2. Disable safe handle function: Toggle the switch to green scale.

One-button mute function

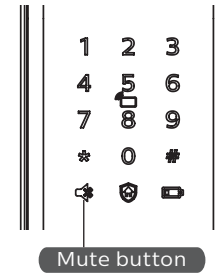

Function:
Use only one button to mute the lock by turning off the voice guide. Applicable to the scenes where you don't want to disturb your family.

- How to use:**
1. **Mute:** When the system is awake, long press the [Mute] button for 2 seconds to enter one-time mute mode. The button will glow green.
 2. **Unmute:** When the system is awake, long press the [Mute] button for 2 seconds to restore the voice guide. The button will glow white.

Restore factory settings: one button to return to initial state

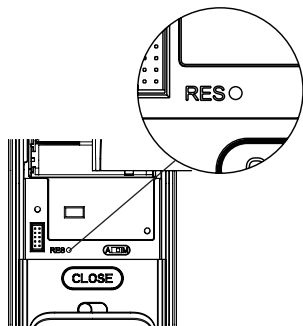

Function:
Empty all user information and return to factory settings.

- How to use:**
Double press the [RES] and all the user information will be emptied. The lock will be restored to factory settings.

Outside forced lock function

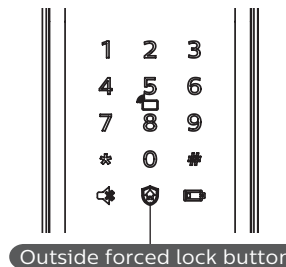

Function:
Unlocking from inside will trigger an alarm.

- How to use:**
After the door is successfully locked, long press the functional button for 2 seconds to enter the outside forced lock mode.

⚠ Attention

Enabling the outside forced lock function will not affect unlocking from outside.

7 Meanings and use of the indicators

Lock status indicator

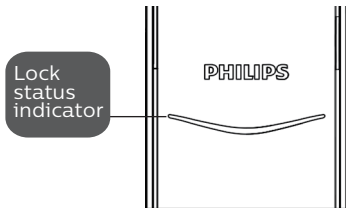

Colors of the light and the corresponding meanings:

Blue: After the system wakes up, the light will glow blue, indicating that you can operate the lock.

Green: After the door is unlocked, the light will glow green, indicating that the door has been opened.

Red: After the door is locked, the light will glow red, indicating that the door has been closed.

Low battery indicator



Colors of the light and the corresponding meanings:

Red: After waking up, the system will run an automatic examination on the battery voltage. If the voltage is too low, the light will flash in red and there will be a voice prompt of "Low battery. Please replace all batteries".

Outside forced lock indicator



Colors of the light and the corresponding meanings:

White:

1. When the door is locked, the light will light up alone, indicating that you can enable the outside forced lock function.

2. If you have enabled the outside forced lock function, the light will light up after the system wakes up, indicating this function is in use.

Mute mode indicator

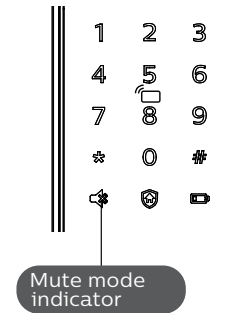

Colors of the light and the corresponding meanings:

1. **White:** Indicates the mute mode is off.

2. **Green:** Indicates the mute mode is on.

Inside deadlock indicator

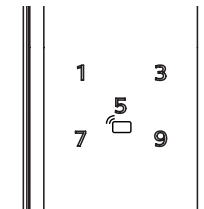

When the door is inside dead locked, the digital functions of the outside escutcheon will be disabled.

If the system is waken up manually, the keypad will display the combination of "15937 (X)" and there will be a voice prompt saying that the inside deadlock has been enabled.

System lock indicator

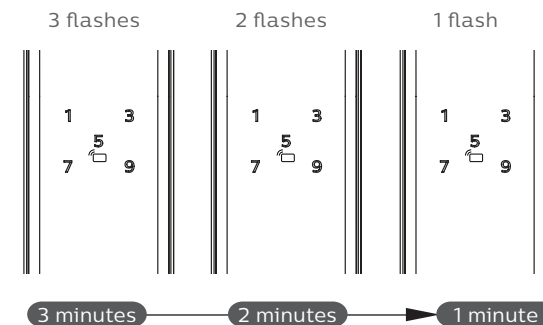

If there are 5 consecutive and incorrect inputs of any of the 3 types of verification information (fingerprint/PIN code/card), this type of verification will be locked for 3 minutes.

⚠ Attention

Only when touching to wake up the keypad or inputting the locked type of verification will the system give such a prompt.

[CLOSE] button indicator



Colors of the light and the corresponding meanings:

1. Red light with 2 flashes: Indicates the door has been locked.
2. Green light with 2 flashes: Indicates the door has been unlocked.
3. Red light with 1 flash: Indicates the door has been dead locked.

Anti-dismantle alarm

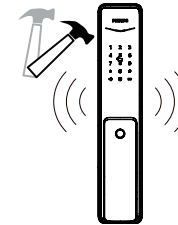

Triggering 1: The door is pried open and the sensor latch bolt pops up.

Alarm mode: Continuous repeated alarms.

Turning off: The alarm can be turned off automatically or by a successful verification.

Triggering 2: Outside escutcheon is pried open and there is no fit to the door.

Alarm mode: Continuous repeated alarms.

Turning off: Auto-close, or close after the successful key verification, or close after the normal indoor unlock.

8 Troubleshooting

Types of alarms and alarm modes

Inside unlocking alarm under outside forced lock mode

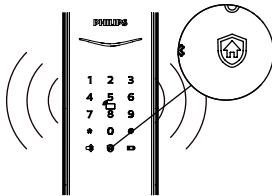

Triggering: If the lock is under outside forced lock mode, unlocking from inside will trigger the alarm.

Alarm mode: Continuous repeated alarms.

Turning off: The alarm can be turned off by a successful verification of any type.

Deadbolt abnormality alarm

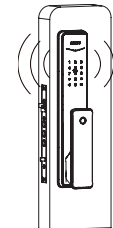

Triggering: The deadbolt works abnormally. The door cannot be locked or unlocked.

Alarm mode: Continuous repeated alarms.

Turning off: The alarm will be automatically turned off.

Low battery alarm, prompting you to replace the batteries in time

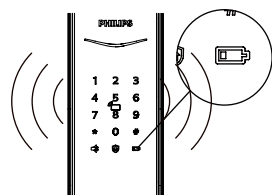

Triggering: After waking up, the system will run an automatic examination on the battery voltage. If the voltage is too low, the lock give an alarm and a voice prompt of "Low battery. Please replace all batteries".

Alarm mode: A voice prompt of "Low battery. Please replace all batteries" during unlocking.

Turning off: The alarm will be automatically turned off.

How to apply an emergency power

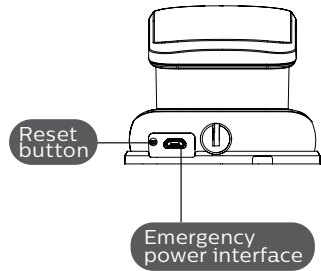

When the battery voltage is insufficient, and the door cannot be opened from the outside, you can power the lock through the Micro USB interface by using a 5V power bank as an emergency power supply. After opening the door lock, please replace the batteries immediately.

In case of a system crash and it's impossible to open the door from outside, please press the Reset button and then release to let it reboot automatically.

How to replace batteries

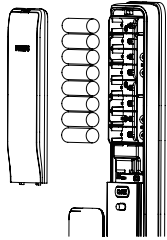

The lock is powered by four 1.5V alkaline batteries. There are two sets of working power inside the battery cabinet. Eight batteries can be put in to extend the battery life and reduce battery replacement frequency. The battery cabinet is located at the upper end of the inside escutcheon. By pushing the cover upwards, you can remove it and then take out the batteries.



Philips and the Philips Shield Emblem are registered trademarks of Koninklijke Philips N.V. and are used under license. This product has been manufactured by and is sold under the responsibility of Shenzhen Conex Intelligent Technology Co., Ltd. and Shenzhen Conex Intelligent Technology Co., Ltd. is the warrantor in relation to this product.

Version:2.0