

**PHILIPS**

**EasyKey**

Alpha series

Smart Video Door  
Lock

Alpha-V-5HWS

# User manual

Register your product(s) to get  
support from below link:

[www.philips.com/support](http://www.philips.com/support)





# Contents

---

<b>1. Important information</b>	02	<b>6. Other functions</b>	16
Security		Indoor infrared sensor unlock	
Caution		Outside forced lock	
Disposal of used products and batteries		Mute mode	
		Restore to default settings	
		Doorbell	
		Two-way video intercom	
<hr/>			
<b>2. Installation</b>	03	<b>7. Indicators meaning and usage</b>	19
Packaging list		Door lock status indicator	
Exploded views		Low battery voltage indicator	
Before installation		Outside forced lock indicator	
Change the orientation of latch bolt		Mute indicator	
Instructions		Interior lockout indicator	
		System lockup indicator	
		[OPEN/CLOSE] indicator	
		Indoor infrared sensor unlock indicator	
<hr/>			
<b>3. Get to know your EasyKey</b>	08	<b>8. Troubleshooting</b>	21
Front escutcheon		Alerts on Philips Easykey	
Rear escutcheon		How to charge EasyKey in an emergency	
		How to replace batteries	
		How to charge lithium battery	
<hr/>			
<b>4. How to set up your Easykey</b>	09		
Before setup			
Enter master mode			
Change master PIN code			
Add a new user			
Delete a user record			
System settings			
Extended functions			
System query			
<hr/>			
<b>5. How to use EasyKey</b>	14		
Unlock from outside or inside			
Lock from outside or inside			
Interior lockout			
Unlock with mechanical key			

---

# 1. Important information

---

## Safety

- ◆ Before using Philips EasyKey, please read and understand all instructions. Damage caused by non-compliance with the instructions will not be covered by warranty.
- ◆ Use only the manufacturer-specified accessories/components.
- ◆ Use only the alkaline batteries the product is equipped with, or use the same specification type of alkaline batteries.
- ◆ Do not forcibly disassemble this product to avoid triggering an alarm or damaging the product.
- ◆ Do not scrape the fingerprint sensor with sharp objects, otherwise it may cause permanent damage.
- ◆ Do not expose products to environments where there is water leakage or splashing.
- ◆ Do not expose the product to corrosive substances to prevent damaging the protective cover.
- ◆ Do not hang objects on the handle, in case it might affect the normal use of the lock.
- ◆ Please clean the product with a soft cloth.
- ◆ Do not remove the battery during setting up and operating.
- ◆ Please let a professional technician to install the door lock and follow the installation guidelines provided. Do not disassemble the lock by yourself. Keep the relevant sealed stickers properly.
- ◆ Please modify the default master PIN code immediately after finishing installing and debugging, and do not easily disclose the password information and also keep the mechanical key properly.
- ◆ Please replace all the batteries immediately if there is a low battery alarm. Please make sure to correctly match the poles (+/-) when installing the batteries.

## Caution

- ◆ Do not place the battery near fire sources to avoid the explosion.
- ◆ Do not use any emergency power supply that does not meet the safety requirements to power up the product.
- ◆ Do not connect the 2 poles of the batteries with metals to avoid short circuit which may lead to an explosion.
- ◆ Please make sure any component replacement is executed by Philips, Philips authorized service center or professional technicians.
- ◆ Do not use accessories or parts that have been produced by other manufacturers or have not been specifically recommended by Philips. The use of such accessories and parts may void your warranty.

## Disposal of used products and batteries

- ◆ You can have your locks reclaimed at Philips authorized service centers. You will receive corresponding compensation if your products meet our conditions.
- ◆ Please familiarize yourself with the local electronic product collection system.
- ◆ Please follow local regulations and do not discard used products into ordinary household waste.
- ◆ Proper disposal of used products can help to avoid potential negative impacts on the environment and human health.
- ◆ Batteries must not be disposed of with ordinary household waste.
- ◆ Please familiarize yourself with the local regulations on batteries classification recycling. Disposing of batteries properly can help avoid a negative impact on the environment and human health.

## 2. Installation

---

### Packaging list

The pictures are for reference only, please refer to the actual packaging items.

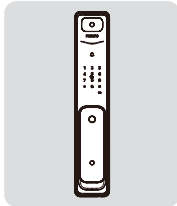

① Front escutcheon with silicone pad

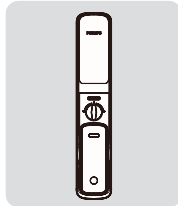

② Rear escutcheon with silicone pad

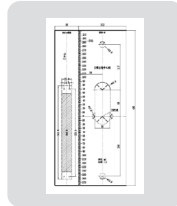

③ Drilling template

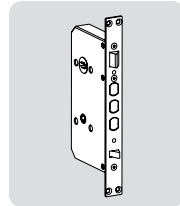

④ Mortise

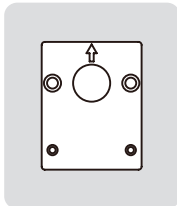

⑤ Mounting plate



⑥ Quick start guide

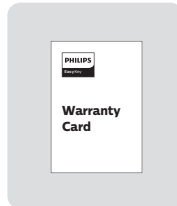

⑦ Warranty card

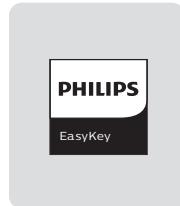

⑧ Quality certificate

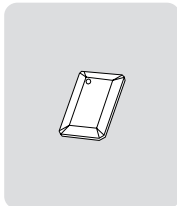

⑨ Key tag

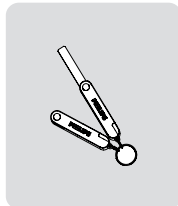

⑩ Mechanical key

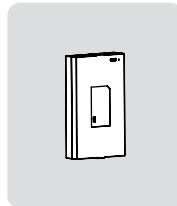

⑪ Lithium battery

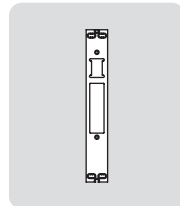

⑫ Strike

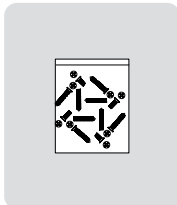

⑬ Installation kit

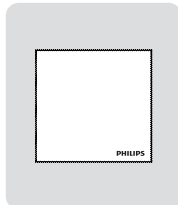

⑭ Cleaning pad

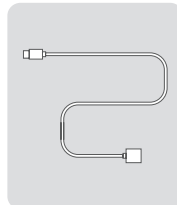

⑮ USB cable

## Exploded views

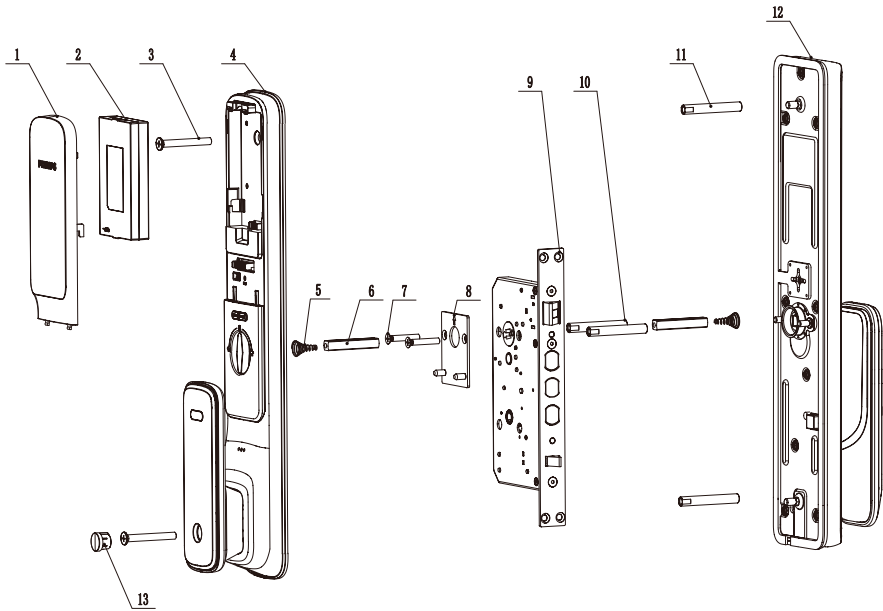

1. Plastic battery cover x1
2. Lithium battery x1
3. M6 anchor screw x2
4. Rear escutcheon x1
5. Compressed spring x2
6. Square shaft x2
7. M5 anchor screw x2

8. Mounting plate x1
9. Mortise x1
10. M5 threaded pipe x2
11. M6 threaded pipe x2
12. Front escutcheon x1
13. Screw cap x1

## Before installation

This product is suitable for the door going in four directions: left outward, right inward, right outward and left inward.

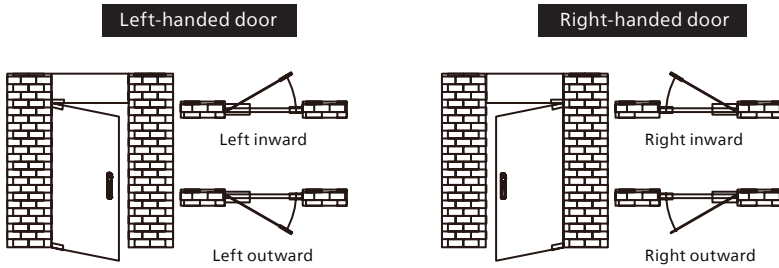

### ⚠ Attention

1. Please choose the proper installation kit to suit your door thickness.
2. The default installation kit is applicable for a door thickness of 60-90mm. If your door thickness does not within this range, please feel free to contact us.

## Change the orientation of the latch bolt

- 1 Loosen the screws by turning them counterclockwise with an Allen wrench and remove the mortise plate.
- 2 Take out the latch bolt and rotate it to 180°, then put it back.

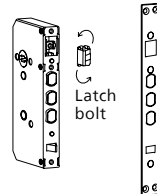
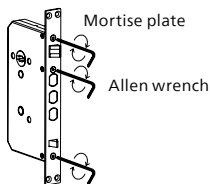

- 3 Mount the mortise plate and fasten it with screws.

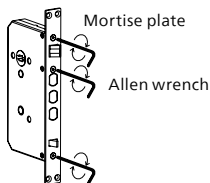

## Instructions

The following installation steps only apply to right-handed door. For left-handed door, please read [Before installation] carefully and make necessary adjustments.

- 1 Mark the hole for drilling with drilling template and drill the marked hole, then mount the mortise into the hole and fasten it with four anchor screws.

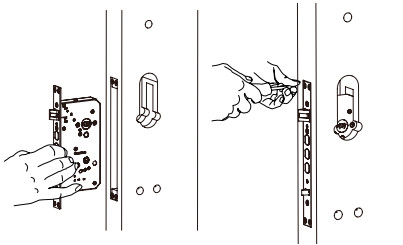

- 2 Install threaded pipes on the front escutcheon and put the compressed spring and square shaft accordingly into the corresponding holes.

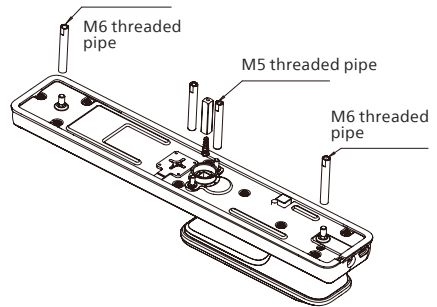

### ⚠ Attention

Make sure the latch bolt stays inside the door during installation.

### ⚠ Attention

Please choose the proper square shaft and threaded pipe to suit your door thickness.

- 3 Pull the connector through the hole and insert the square shaft into the hole on the mortise, making sure the front escutcheon is flush against the door.

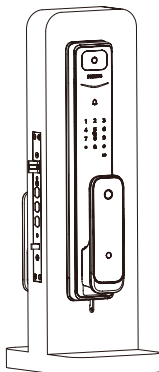

- 4 Place the mounting plate on the door and fasten it with two M5 anchor screws.

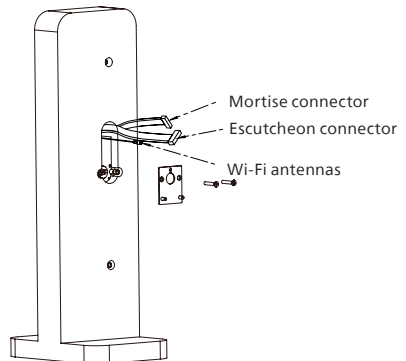



- 5 Put the compressed spring and square shaft into the hole of the rear escutcheon accordingly.

- 6 Connect the connector of escutcheon and mortise as well as the wi-fi antennas to the connector port of rear escutcheon. Then insert the square shaft into the hole on the mortise, making sure the rear escutcheon is flush against the door.

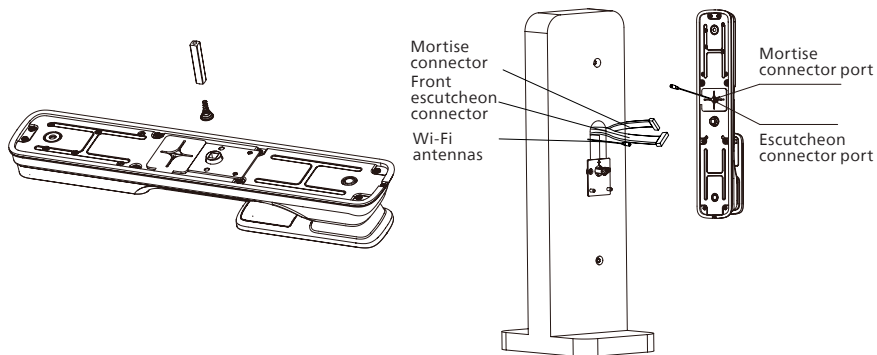

**Attention**

Please hide the extra connector in the door hole or the inside escutcheon.

- 7 Remove the front cover and the battery cover. Insert and tighten M6 anchor screws to secure the rear escutcheon as indicated in illustration.

- 8 Put the deco cover back, install the lithium battery, and install the battery cover along with the strike.

- 9 Check whether the rotary knob, mechanical key, and all other components work properly.

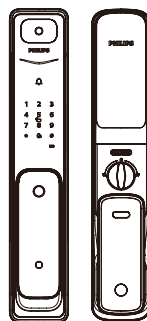
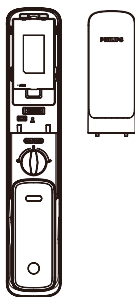
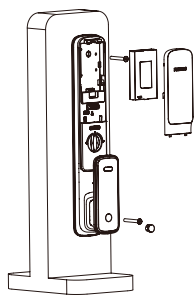

**Attention**

Once installed the strike, please test the locking and unlocking function.

# 3. Get to know your EasyKey

The pictures are for reference only, please refer to the actual packaging items.

## Front escutcheon

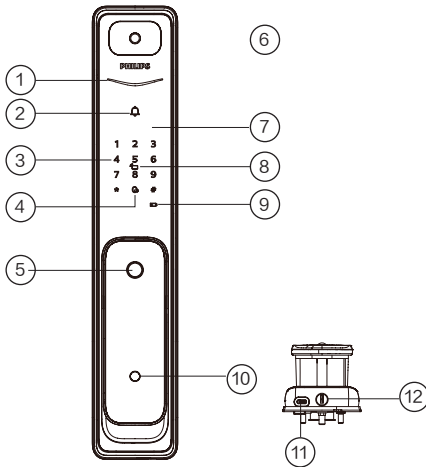

①	Door lock status indicator
②	Doorbell
③	Keypad
④	Mute key
⑤	Fingerprint sensor
⑥	Camera
⑦	Push-pull handle
⑧	Keytag reader
⑨	Low battery voltage indicator
⑩	PIR sensor
⑪	Reboot and USB interface
⑫	Key hole

## Rear escutcheon

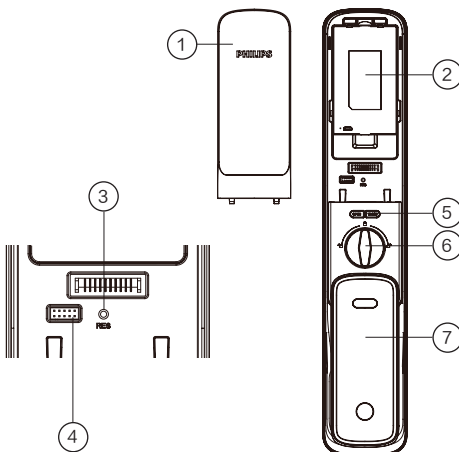

①	Battery cover
②	Battery compartment
③	[RES] button
④	Burning port
⑤	[OPEN/CLOSE] button
⑥	Rotary knob
⑦	Push-pull handle

# 4. How to set up your EasyKey

## Pre-setup instructions

◆ Philips EasyKey comes with two modes: General mode and Dual verification mode.

<b>General mode</b>	Unlock with any registered identity information
<b>Dual verification mode</b>	Unlock with the combination of two different verifications among PIN code, Key tag and fingerprint.









### ◆ User code

If you want to delete a specific user's information, you could delete the related user code in the system.

You can use the below template to write down all user information for review.

User code	Name	Fingerprint	PIN code	Keytag
00				
01				
02				
03				
04				
05				
06				
07				
08				

### ◆ Icon annotation

								
Master PIN code	One-time PIN code	User PIN code	User code (00-99)	Master fingerprint	Fingerprint	Keytag	[#]	[*]

### ▲ Attention

1. Press [\*] key to return to the previous menu.
2. The default master PIN code is 12345678.

## How to enter master mode

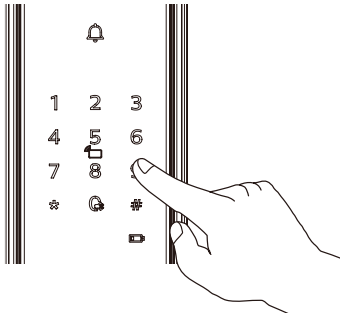

Wake up the keypad and enter [#] twice before you enter any other numbers, then enter master PIN code and enter [#] to enter the master mode.

### ⚠ Attention

If the master PIN code is the default PIN of 12345678, please follow the below steps to change the master PIN code on keypad first: enter master mode, enter [1] followed by [5] and then enter the new master PIN code.

## Master fingerprint

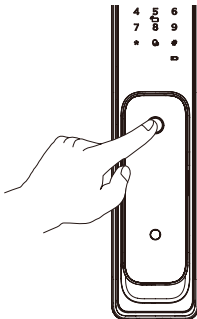

Light up the keypad and enter [\*] twice before you enter any other numbers. Then place the registered master fingerprint against fingerprint sensor to go into the master mode.

### ⚠ Attention

1. Product in factory mode does not come with master fingerprint, please enroll a master fingerprint first before operation.
2. It is recommended that the master fingerprint and user fingerprint should not share the same finger.

## User settings

### Add a new user PIN code



Enter [\*] twice followed by master PIN code, and confirm with [#].



Enter [1] to go to user setting and enter [1] again to add user information. You can directly add a desirable information (PIN code, fingerprint or Key tag) and the system will automatically identify and add what you have entered.



Way to add a new PIN code: Enter a new user PIN code and confirm with [#]. Enter the new PIN code again and confirm with [#]. Once heard a voice prompt of "Succeeded", keep pressing [\*] until you finally exit the master mode.

Way to add a fingerprint: Place your finger on the fingerprint sensor. When you hear a voice prompt of "Move your finger and put on again", lift your finger and repeat the process until you hear a voice prompt of "Succeeded". After you have successfully registered your fingerprint, keep pressing [\*] until you finally exit the master mode.

Way to add a Keytag: Place the key tag against the keytag reader. After hearing a voice prompt of "Succeeded", keep pressing [\*] until you finally exit the master mode.

### Add a one-time PIN code



Enter [\*] twice followed by master PIN code and confirm with [#].



Enter [1] to go to user settings and enter [2] to add a one-time PIN code.



Enter a one-time PIN code of 6 to 12 digits and confirm with [#]. Re-enter the one-time PIN code and confirm with [#]. Once heard a voice prompt of "Succeeded", keep pressing [\*] several times until you exit master mode.

### Add or change master fingerprint



Enter [\*] twice followed by master PIN code and confirm with [#].



Enter [1] to go to user settings and enter [4] to add or change master fingerprint.



Without registered fingerprint: Enroll a finger as a master fingerprint. Once heard a voice prompt of "succeeded", keep pressing [\*] until you finally exit master mode.  
With registered fingerprint: Enroll a new finger to replace the old one. Once you heard a voice prompt of "succeeded", keep pressing [\*] until you finally exit master mode.

### Change master PIN code



Enter [\*] twice followed by master PIN code and confirm with [#].



Enter [1] to go to user settings and enter [5] to change master PIN code.



Enter a new master PIN code and confirm with [#]. Enter the new master PIN code again and confirm with [#]. Once heard a voice prompt of "succeeded", keep pressing [\*] until you finally exit master mode.

### Deletion of user information



Enter [\*] twice followed by master PIN code and confirm with [#].



Enter [1] to go to user settings and enter [6] to delete user information.



Choose the information that is to be deleted: Delete a single PIN code, press [1]; Delete a single fingerprint, press [2]; Delete a single Keytag, press [3]; Delete all user information, press [5]. Please follow the voice guide to delete a specific information. Once heard a voice prompt of "succeeded", keep pressing [\*] until you finally exit master mode.

# System settings

## Language settings



Enter [\*] twice followed by master PIN code and confirm with [#].



Enter [2] to go to system settings and enter [1] to set language.



Choose the language as needed: For Chinese, press [1]; for English, press [2]. After hearing a voice prompt of "Succeeded", press [\*] until you finally exit the master mode.

### ⚠ Attention

The default language is English.

## Volume settings



Enter [\*] twice followed by master PIN code and confirm with [#].



Enter [2] to go to system settings and then enter [2] to enter volume settings.



Choose the volume as needed: For high volume, press [1]; for low volume, press [2]; for mute mode, press [3]. After hearing a voice prompt of "Succeeded", press [\*] until you finally exit the master mode.

### ⚠ Attention

The default volume is "high volume".

## Eco mode



Enter [\*] twice followed by master PIN code and confirm with [#].



Enter [2] to go to system settings and then enter [3] to go to eco mode.



Enter [1] to turn on or turn off the eco mode. Once heard the voice prompt of "Succeeded", keep pressing [\*] until you finally exit the master mode.

### ⚠ Attention

The eco mode turns off by default.

## Dual verification mode



Enter [\*] twice followed by master PIN code and confirm with [#].



Enter [2] to go to system settings and then enter [4] to enable or disable the dual verification mode. Once heard a voice prompt of "Succeeded", keep pressing [\*] until you finally exit the master mode.

### ⚠ Attention

The default verification option is single verification.

## Infrared sensor



Enter [\*] twice followed by master PIN code and confirm with [#].



Enter [2] to go to system settings and then enter [5] to enable or disable the infrared sensor. Once heard a voice prompt of "Succeeded", keep pressing [\*] until you finally exit the master mode.

### **Attention**

The infrared sensor turns on by default.

## Network setting

### Network connection



Enter [\*] twice followed by master PIN code and confirm with [#].



Enter [4] to join a network. After a successful network connection, the system will automatically exit the master mode.

## App pairing guide

① Download official App  
Please search and download Philips EasyKey Plus on your phone.

② Lock intergration  
Option 1: QR code scanning  
1. Power on your door lock and find the QR code placed on the battery cover.  
2. Sign in official app and choose "Add a device" on the first screen to enter QR code scanning page.  
3. After scanning the QR code on the battery cover, please follow the instructions to complete the pairing set up in the app.

Option 2: Manual operations  
1. Sign in official app and tap "Add a device" in the first screen and choose "Manual".  
2. Perform a search for product model on current page and then go to network connection page.  
3. Enter [\*] twice on the door lock, then enter master PIN code and confirm with [#] to go to master mode. Enter [4] to join a network and you will hear a voice prompt of "Connecting, please wait a moment".



③ Return to official app and follow the instructions to complete the pairing set up .

### **Attention**

Philips Easykey is only compatible with a router with dedicated 2.4 Hz (5G Hz Wi-Fi is not supported). Please make sure the distance between the door lock and the router is less than 10 meters, otherwise the connectivity of the router will be affected.

# 5. How to use EasyKey

## Unlock from inside or outside

### Unlock from outside

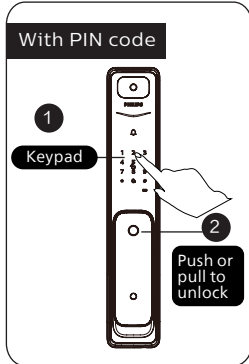

①Touch the digit input area to light up the keypad and enter the registered PIN code and confirm with [#].  
②After hearing a voice prompt of "Door opened", push or pull the handle to unlock the door.

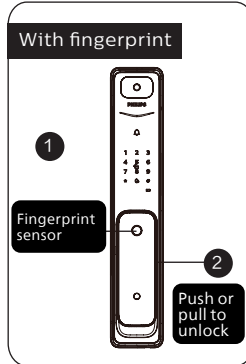

①Place the registered finger on the fingerprint sensor.  
②When you hear a voice prompt of "Door opened", push or pull the handle to unlock the door.

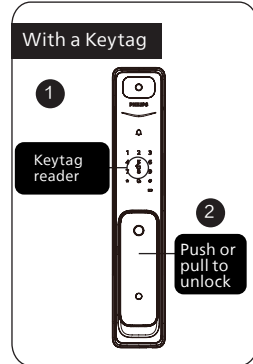

①Place the registered Keytag against the keytag reader.  
②After hearing a voice prompt of "Door opened", push or pull the handle to unlock the door.

### Unlock from inside

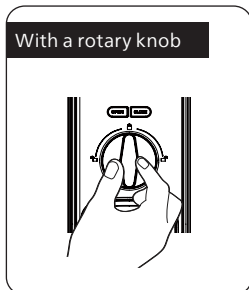

Philips EasyKey adopts indoor fast opening mortise. You can unlock the door from inside by rotating the rotary knob.

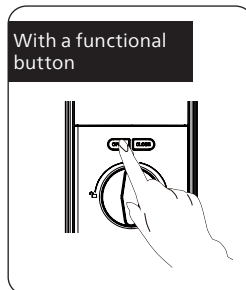

Double press the [OPEN] functional button within one second, then push or pull to unlock the door.

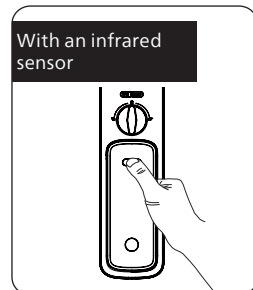

Philips Easykey has an infrared sensor on the handle. When the sensor is triggered, you can press the sensor module on the front and rear sides of the handle simultaneously to unlock the door.



## Lock from outside or inside

The latch bolt will pop up automatically as soon as the door is close and there will be a voice prompt of "Door Close".

## Interior lockout

---

When the door lock is locked, long press the [CLOSE] button and there will be a voice prompt of "inside deadlock enabled"

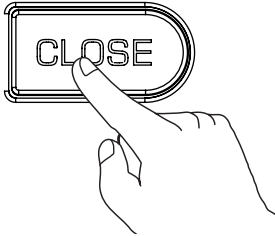

### ⚠ Attention

1. When the door is under interior lockout mode, the front escutcheon will lock up. When you verify your identity, the combination of "15937(X)" will be visible on the keypad and there will be a voice prompt of "Inside deadlock enabled" to remind you that the door has been deadlocked from inside.
2. Under interior lockout mode, all operations of front escutcheon are disabled. Master PIN code verification or mechanical key opening is required to release the door from interior lockout mode.

---

## Unlock with mechanical key

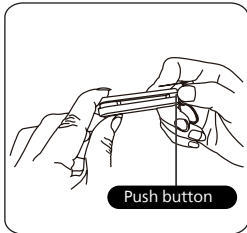

① Cut the mechanical box and take out the key. Push the cover aside and reveal the key.

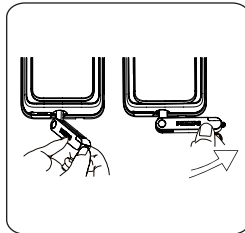

② Insert the key into the keyhole and the key should be vertical to the key shell. Then turn the key shell by 90° in the direction of the handle until it is close to the lock.

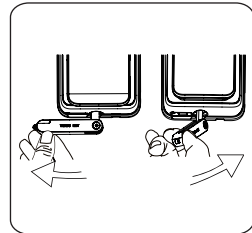

③ Make a 180 degrees twist clockwise and make sure the key shell is parallel to the horizontal plane. Then rotate the key cover horizontally in the direction of the handle to unlock.

### ⚠ Attention

It is recommended not to use mechanical keys daily unless there is an emergency, such as a dead battery, forgotten PIN code or system malfunction.

# 6. Other functions

---

## Indoor infrared sensor

---

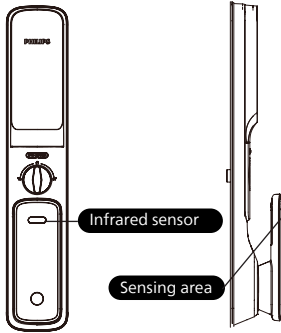

**⚠ Attention**

When the infrared sensor is disabled, the indoor inductive unlocking would be inactive. When you touch both the front and rear side of the sensing area on the handle, the red light will light up to remind you that the indoor inductive unlocking is off.

**Function:**

Once the indoor infrared sensor is enabled, you could easily unlock the door from inside.

**How to use:**

Philips Easykey has an infrared sensor on the handle. Once the sensor is triggered, you can touch the sensing area on the rear and front side of the handle simultaneously to unlock the door.

**Enable/Disable:**

When the infrared sensor is disabled, long press the [OPEN/CLOSE] button at the same time to turn it on.

When the infrared sensor is enabled, long press the [OPEN/CLOSE] button at the same time to turn it off.

---

## Outside forced lock

---

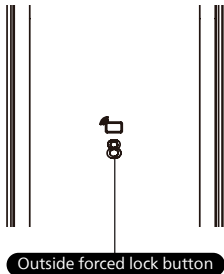

**Function:**

Unlocking from inside will trigger an alert.

**How to use:**

Once locking the door successfully, long press the number key "8" for 2 seconds to enter outside forced lock mode.

**⚠ Attention**

Enabling the outside forced lock function will not affect the normal way to unlock the door from outside.

## Mute mode

---

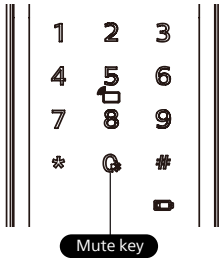

### Function:

Turning off the voice guide with only one key, which is applicable to the scenes where you don't want to disturb your families.

### How to use:

1. Mute: When the system is awake, long press the [Mute] key for 2 seconds to enter mute mode and there will be a voice prompt of "Mute mode".

2. Unmute: When the system is awake, long press the [Mute] key for 2 seconds to turn off the mute mode and there will be voice prompt of "Voice mode".

## Restore to default settings

---

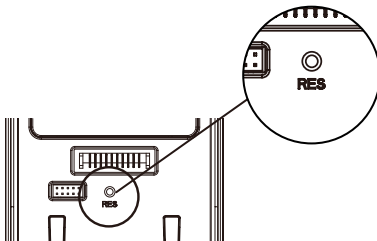

### Function:

Empty all user information and restore the EasyKey to default settings.

### How to use:

Double click the [RES] button with a sharp object. Then the door lock will be restored to factory settings and all the user information will be emptied.

## Doorbell

---

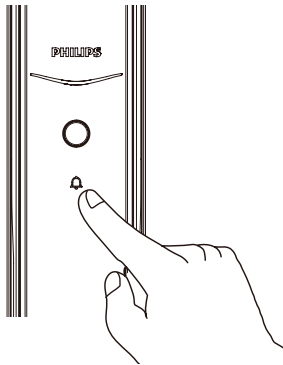

### Function:

When the doorbell make sound, it indicates that someone comes in the door.

### How to use:

When the visitor press the doorbell on the keypad, the indoor chime will produce a dingdong bell sound. Meanwhile, the camera of smart lock will capture a video clip of the visitors and send it straight to the paired app. When you get a notification on your phone, you can check the situation outside your front door remotely via app.

### Attention

Once pressing the doorbell key, the smile curve indicator will flash in blue.

---

## Two-way video intercom

---



### Function:

View the situation outside the front door and talk to the visitors via mobile app.

### How to use:

When the door lock is intergrated with the mobile app, you can check the situation outside the front door and talk to the visitors in real time on app.

---

# 7. Indicators meaning and usage

---

## Door lock status indicator

---

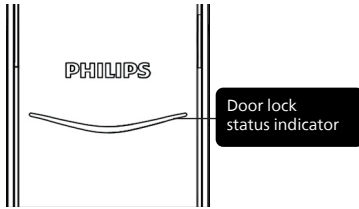

**Blue:** When the system wakes up and the light glows blue, it means you can operate the lock.

**Green:** When the door is unlocked and the light glows green, it means the door is open.

**Red:** When the door is locked and the light glows red, it means the door is closed.

## Low battery voltage indicator

---

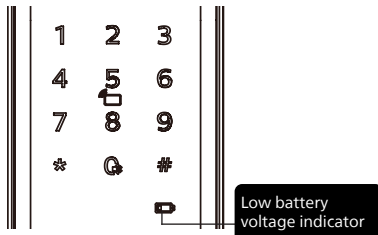

**Red:** When the system wakes up, it will automatically check the battery voltage. If the voltage is too low, then the indicator will flash in red and there will be a voice prompt of "Low battery voltage, please replace battery".

## Outside forced lock indicator

---

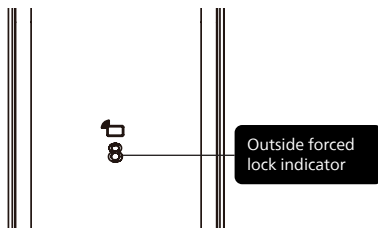

**White:**

When the door is locked and the number key "8" is glowing, it means that you can enable the outside forced lock mode.

## Interior lockout indicator

---

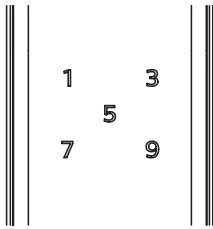

When the door is under inside deadlock mode, the keypad will lock. If you wake up the system manually, the keypad will show the combination of "15937 (X)" with a voice prompt of "inside deadlock enabled".

## System lockup indicator

---

Number key "2" flash

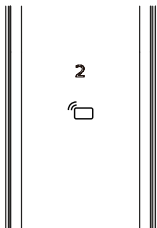

Within 2 minute

Number key "1" flash

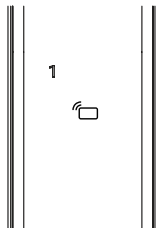

Within 1 minute

If there are consecutive incorrect inputs of any of the fingerprint, PIN code or Keytag 5 times within 5 minutes, the system will lock for 100 seconds.

### **⚠ Attention**

Only when waking up the outside escutcheon or verifying the identity of the user would the numbers appear.

# 8. Troubleshooting

## Alerts on Philips Easykey

### Alert to unlock from inside under outside forced lock mode

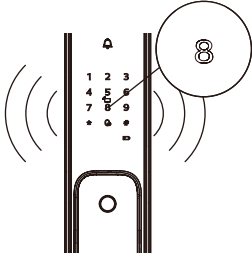

**Way to trigger:** Under outside forced lock mode, an alert will be triggered when the door is unlocked from inside.

**Way to be alerted:** Repeat alerts

**Way to turn off:** The alert will be turned off once the identity verification is successful.

### Low battery voltage alert reminds you to replace the battery

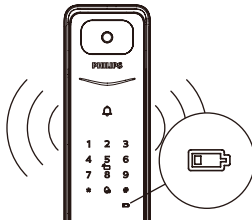

**Way to trigger:** When the system wakes up, it will automatically check the battery voltage. If the voltage is too low, then an alert will be triggered to remind you to replace the battery.

**Way to be alerted:** A voice prompt of "Low battery voltage, please replace all batteries" will be given when unlocking the door.

**Way to turn off:** The alert will be automatically turned off.

### Anti-dismantling alert

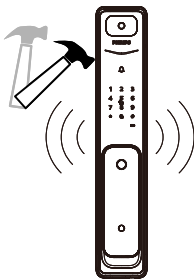

**1. Way to trigger:** The door is pried apart and the latch bolt pop out.

**Way to be alerted:** Repeat alerts.

**Way to turn off:** Automatically turning off or successful identity verification.

**2. Way to trigger:** The front escutcheon is pried open and there is a gap between the door frame and the door lock.

**Way to be alerted:** Repeat alerts.

**Way to turn off:** Automatically turning off or successful identity verification or a normal way to unlock the door from inside.

## Anomalous deadbolt alert

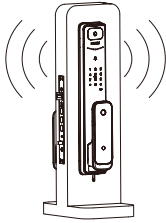

**Way to trigger:** The deadbolt works abnormally and causes a failure in locking or unlocking the door.

**Way to be alerted:** Repeat alerts

**Way to turn off:** The alert will be automatically turned off.

## Motion sensor alert

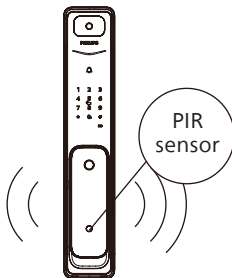

**Way to trigger:** When an unexpected person enters the detected area and stays there over the given time, an alert will be triggered.

**Way to be alerted:** The camera will capture a short video and sent notifications to the mobile app.

**Way to turn off:** The motion sensor alert turns off by default. To use this function, you can turn it on or off on the mobile app.

### Attention

1. Once the smart door lock is restored to default settings, the PIR motion sensor is turned off by default. In order to turn it on, please install the official app first and choose "Add a device" on the first screen. After a successful intergration with smart door lock, please open the setting page on app, go to "motion sensor alert" and turn it on.

2. The increasing operating frequency of video functions on the door lock can increase the power consumption, so it is recommended to set the minimum sensitivity level of the motion sensor, reducing the test times and power consumption.



## How to charge EasyKey in an emergency

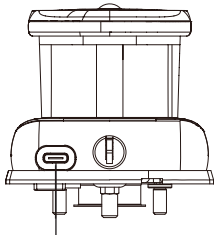

Reboot and USB interface

When the battery voltage is low and the door can not be opened from outside, you can power up the door lock by plugging 5V power bank into the micro USB. After unlocking the door, please replace the battery instantly. If system crash occurs and the door lock can not be opened from the outside, you can power up the door lock using 5V power bank and the system will reboot itself automatically.

## How to replace battery

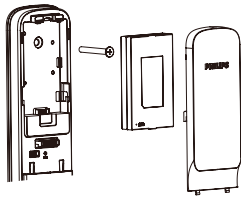

Philips Easykey is powered by a 5000mA/h lithium battery. The battery compartment is in the upper part of the rear escutcheon. Push the battery cover upward and remove it, then replace the battery.

## How to charge the lithium battery

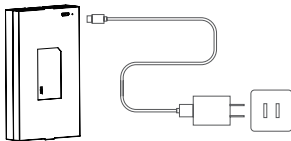

Remove the battery from the door lock, and charge it via a charging cable.

### ⚠ Attention

1. Lithium battery is guaranteed for one year.
2. For a lithium battery, the charge cut-off voltage is 5V.
3. A bad network connection will increase power consumption at a faster rate.



Philips and the Philips Shield Emblem are registered trademarks of Koninklijke Philips N.V. and are used under license. This product has been manufactured by and is sold under the responsibility of Shenzhen Conex Intelligent Technology Co., Ltd, and Shenzhen Conex Intelligent Technology Co., Ltd is the warrantor in relation to this product.